



FLORIDA ATLANTIC UNIVERSITY  
OFFICE OF INFORMATION TECHNOLOGY  
*formerly Information Resource Management*

## **OIT INFRASTRUCTURE SPECIFICATION**

**as of May 2016**

# OIT SPECIFICATION TABLE OF CONTENTS

<b>1.1 OVERVIEW</b>	
<b>1.2 INTRODUCTION</b> .....	<b>1</b>
1.2 SCOPE OF WORK.....	1
1.3 TERMINOLOGY AND ACRONYMS.....	2
<b>2.0 ADMINISTRATION</b> .....	<b>3</b>
2.1 OIT INFRASTRUCTURE MANAGERS AND CONTACTS .....	3
2.2 ASSIGNMENT OF OIT/CI RELATED RESPONSIBILITIES .....	3
2.3 ADMINISTRATIVE PROCESS .....	4
2.4 SUBMITTALS AND RECEIVABLES.....	5
2.5 EQUIPMENT MANUFACTURERS CURRENTLY USED.....	6
<b>3.0 DESIGN AND IMPLEMENTATION</b> .....	<b>7</b>
3.1 SUMMARY OF STRUCTURED CABLING SYSTEM COMPONENTS.....	7
3.2 OUTSIDE PLANT.....	8
3.3 CAMPUS INFRASTRUCTURE LAYOUTS.....	9
3.4 OUTSIDE PLANT CABLING INFRASTRUCTURE.....	9
3.5 BUILDING SERVICE ENTRANCE FACILITIES.....	10
3.6 OIT ROOMS .....	11
3.7 RISER CABLE .....	14
3.8 HORIZONTAL CABLE.....	14
3.9 WIRELESS .....	15
3.10 ADDITIONAL APPLICATIONS.....	16
3.11 LABELING .....	17
3.12 CODE REFERENCES.....	18
3.13 OIT REQUIREMENTS FOR ARCHITECT/ENGINEER .....	19
3.14 OIT REQUIREMENTS FOR ELECTRICAL CONTRACTOR .....	20
<b>4.0 LOGISTICS</b> .....	<b>22</b>
<b>5.0 APPENDICES</b> .....	<b>23</b>
5.1 APPENDIX A: CHANGE ORDER/VARIANCE REQUEST FORM.....	24
5.2 APPENDIX B: OIT ROOM LAYOUTS AND RACK ELEVATION .....	26
5.3 APPENDIX C: WIRELESS ACCESS POINTS .....	30
5.4 APPENDIX D: GROUNDING AND BONDING .....	31
<b>6.0 INSTRUCTIONAL TECHNOLOGIES SPECIFICATION</b> .....	<b>32</b>

## **1.0 OVERVIEW**

### **1.1 INTRODUCTION**

Florida Atlantic University (FAU) is a dynamic, six-campus university that stretches over 150 miles of South Florida coastline and serves Broward, Indian River, Martin, Okeechobee, Palm Beach and St. Lucie Counties. The Office of Information Technology (OIT) Specification was developed by Communication Infrastructure (CI) to provide consistent, best practices across all campuses and to better manage the growth, distribution and diversity of the communications environment in which FAU functions. The standards presented in this document are periodically reviewed and updated but may only be changed or amended by FAU's CIO or the CIO's designee. All Construction Managers, sub-contractors and their employees are required to adhere to the specifications presented in this document.

**NOTE:** Any requirements or issues not addressed in this document will be addressed on a case-by-case basis with Communication Infrastructure, Design and Construction Services, and/or the appropriate contractor.

Contractors are required to verify with CI that no changes to this document have taken place or are in progress.

### **1.2 SCOPE OF WORK**

The scope of work covered in this document includes the administration, design, furnishing, logistics, and installation, of all communication cabling infrastructures on all FAU Campuses. This includes, but is not limited to:

Outside plant (OSP) cabling and non-cabling infrastructure for voice, data, security, video, wireless applications, and miscellaneous services.

Inside plant in the form of a client-selected structured cabling system (SCS).

Installation of wireless access points, related enclosures, antennas, and cabling infrastructure.

OIT non-switching furnishings as required by the project.

Actual installation of communications equipment/switches is the responsibility of OIT.

### 1.3 TERMINOLOGY AND ACRONYMS

**IDR:** Intermediate Distribution Room. A room that houses OIT equipment and is connected back to the Main Building Distribution Room. This room has no direct connection to the public network.

**OIT:** Office of Information Technology

**OIT Room:** Generic term for any room dedicated to housing OIT equipment (voice/data/video)

**ISP:** Inside Plant. Generic term for all cabling infrastructure located inside a building.

**LEC/CLEC:** Local Exchange Carrier/Competitive Local Exchange Carrier. The local dial tone provider (AT&T)/Alternate service providers (Verizon, Sprint, etc).

**MBDR:** Main Building Distribution Room. Serves as an aggregation point for the IDRs in the building and provides the link(s) to the campus networks (voice/data/video).

**MCDR:** Main Campus Distribution Room. Serves as an aggregation point for all the buildings on a campus and provides the links to the public network.

**MM:** Multi-mode fiber optic cable.

**OSP:** Outside Plant. Generic term for all cabling infrastructure not located in a building.

**SCS:** Structured Cabling System. Generic term for single manufacturer, end-to-end communications infrastructure. Provides guaranteed quality and functionality of product for twenty-five years.

**SM:** Single-mode fiber optic cable.

**WAP:** Wireless Access Point. Provides communication connectivity for wireless devices such as laptop computers and cell phones in a specified area.

## 2.0 ADMINISTRATION

### 2.1 OIT INFRASTRUCTURE MANAGERS AND CONTACTS

OIT Infrastructure Project Managers (IMs) report to Communication Infrastructure (CI) and are responsible for the design and installation of all communications infrastructure for all major/minor FAU projects and renovations. The IM assigned to the project is the primary point of contact for all low voltage/OIT project related issues. CI assigns a single IM to carry out the field portion of each project. Functional aspects and issue clarifications are addressed through the Director of CI, Ken Rothhaar, 561-297-2025, [ken@fau.edu](mailto:ken@fau.edu) or, in his absence, the Manager of Technical Services, Ivette Puga, at 561-297-2555, [ipuga@fau.edu](mailto:ipuga@fau.edu).

### 2.2 ASSIGNMENT OF OIT/CI RELATED RESPONSIBILITIES

#### ARCHITECT

**Construction Drawings:** All phases.

**Inclusion of OIT/CI drawing related comments:** Comments regarding communications infrastructure are received by the FAU Design and Construction Services department and forwarded to the appropriate architect for inclusion in the next set of drawings. Comments regarding low voltage issues and applications received from areas other than CI management should be forwarded to CI management for approval and inclusion.

#### ELECTRICAL CONTRACTOR

**Non-Cable Inside/Outside Plant Components:** include conduit (external and internal), raceways, cable trays, manholes/hand-holes and junction boxes. Size, quantity, and configuration are determined by CI Management/ Design and Construction Services.

**Entrance Facilities:** Are project dependent and configured cooperatively by CI and Design and Construction Services.

**Electrical/HVAC Requirements:** See section 3.14, Requirements for Electrical Contractor, for details.

#### LOW VOLTAGE CONTRACTOR

**Outside and Inside Plant Cabling:** Designed by CI and installed by the Low Voltage Contractor using OIT specification guidelines. All work and/or exceptions must be submitted to CI for approval. See Section 5.1, Appendix A: Change Order/Variance Form, for the OIT Form required to request exceptions to the OIT Specification. Once approved, pathways are re-configured on the construction documents by the OIT Project Manager, approved by the Director and forwarded to Design and Construction Services for final approval and incorporation by the architect.

**OIT Room Layouts:** Designed by the Low Voltage Contractor and CI using specification guidelines. See Section 5.2, Appendix B: OIT Room Layouts and Rack Elevation for representative drawings.

**Non-Switching Equipment Installation:** Includes cabinets, shelves, racks, cable management and is installed by the Low Voltage Contractor after the layout is approved by CI.

**Warranties and As-Builts:** upon project completion.

## **2.3 ADMINISTRATIVE PROCESS**

### **Project Meetings**

OIT/CI Managers represent all aspects of OIT and attend Design and Construction Services project meetings as scheduled. Additionally, CI holds regular project meetings to coordinate all related communication requirements: voice, networking, distance learning, electronic classrooms, video conferencing, wireless, network security, security cameras, lockdowns, cabling, and equipment installation as well as moves, changes, and order processing. Representatives from the FAU Public Safety Department, the Low Voltage Contractor, and the Manufacturers also attend.

### **Vendor/Contractor Quotations**

Quotations are provided at the request of the OIT Infrastructure Project Manager or CI Support Services. Quotations shall be all-inclusive and represent complete installation, testing and certification. The Contractor shall be responsible for all labor, and other associated apparatus, tools and equipment necessary to completely install, test, certify and turnover for acceptance to FAU. CI does not routinely use the bid process, instead, a Request for Proposals (RFP) is issued for cabling products and installation. Equipment is generally purchased using the State of Florida Contract. Non-RFP or state contract items are handled on a case-by-case basis in accordance with State of Florida purchasing procedures.

### **Scheduling**

The overall project schedule is determined by FAU Design and Construction Services. CI and its contractors work within this schedule. Any planned communication outages are coordinated by CI in cooperation with Design and Construction Services. Upon receipt of purchase order, the installation schedule is to be submitted to CI within three (3) business days.

### **Invoicing**

All invoices for project-related low voltage infrastructure and equipment are to be sent to:

Florida Atlantic University  
Controller's Office  
777 Glades Rd  
Bldg. 10, Room 149  
Boca Raton, FL 33431

CI approval is required before payment will be made by Design and Construction Services. All applicable State of Florida statutes apply.

### **Certifications**

All work shall be performed by firms and individuals skilled and licensed in their respective trades, as applies to their portion of the work. The Low Voltage Contractor is required to hold a valid and approved structured cabling system certification. All cable/fiber must be pulled/installed and terminated by technicians who are manufacturer certified.

### **Change Orders**

Change orders involving low voltage issues must be approved by CI before going to Design and Construction Services for approval. See Section 5.1, Appendix A: Change Order/Variance Request Form, for the necessary form.

## **2.4 SUBMITTALS AND RECEIVABLES**

### **Submittals from Architect/ Design and Construction Services to CI**

The Architect or Representative should consult with Design and Construction Services in conjunction with CI for requirements and provide timely, written responses to OIT comments. However, all projects shall minimally include the following:

- A. Timely, written responses to OIT comments on drawings and acknowledgement of receipt of the comments by The Architect and Engineer
- B. Advanced Schematics /Design Development Drawings
- C. 50% Drawings
- D. 100% or Construction Drawings (with furniture layout) and one full set of all addenda with two additional copies of the E sheets
- E. Complete set of accurate as-builts to Design and Construction Services /CI upon completion of project
- F. All applicable punch lists

### **Submittals to CI from Low Voltage Contractor**

- A. Room Design/Layout (done in conjunction with CI)
- B. Riser Diagrams (done in conjunction with CI)
- C. Test Results
- D. Manufacturer Warranty
- E. Cabling Infrastructure As-Builts (in format appropriate for CAD/PDF and/or Paper as needed for IDRs)
- F. Updates to As-Builts for all Renovations and Additions.

### **Receivables from CI to Architect/ Design and Construction Services**

- A. OIT Program Budget
- B. Project Specifications
- C. Comments on Drawings, All Phases
- D. Project Consolidated Quotation
- E. OIT Room Layouts and Configurations

## **2.5 EQUIPMENT MANUFACTURERS CURRENTLY USED**

Equipment Manufacturers Currently Used by OIT are:

A. AMP NETCONNECT Category 6/6A Structured Cabling System (SCS): includes all components from outside plant to outlet face plates. CI approval is needed for use of any other manufacturer's Structured Cabling System which must meet or exceed performance and engineering specifications of the current product to be considered. RG6 coax cable is used from the OIT Room to the faceplate to support CATV and is pulled simultaneously with inside cable. These products are purchased through and installed by FAU's Low Voltage Contractor.

NOTE: Video OSP is determined and installed by the cable television provider. See Section 6.0, Instructional Technologies Specification.

B. Chatsworth: (CPI) data racks, cable management,

C. Cisco: network equipment, wireless access points and devices.

D. Unify: voice systems.

E. APC: cabinets (exact model determined on a case-by-case basis).

F. Panduit.



## 3.0 DESIGN AND IMPLEMENTATION

### 3.1 SUMMARY OF STRUCTURED CABLING SYSTEM (SCS) MAJOR COMPONENTS \*

The major components of the complete FAU Structured Cabling System are:

- A. Conduit, manholes/hand-holes, junction boxes, and lids, installed by the electrical contractor, must meet OIT specifications. Low and high voltage can not be collocated in the same conduits, trays, holes or boxes.
- B. Outside Plant (OSP): a minimum of one 24 strand single mode fiber per building. Copper OSP will be a minimum of 25 pair. Final count is determined by OIT/CI on a case-by-case basis.
- C. Building Service Entrance Facilities.
- D. Fully specification compliant OIT Rooms with sufficient HVAC and electrical power for communication equipment plus racks, cabinets, wire management, patch panels and patch cords.

NOTE: Voice/Data/Video equipment is not the responsibility of the Construction Manager nor the Low Voltage Contractor. Communication equipment is purchased by the project as requested by OIT.

- E. Fiber, copper, and RG6 risers as specified herein.
- F. Inside Plant (ISP) consists of a plenum-rated riser and horizontal Category 6/6A SCS, which is a complete, single-manufacturer, end-to-end engineered system whose performance characteristics meet or exceed those of the existing AMP NETCONNECT Structured Cabling System. Only parts that comply with the manufacturer's written specification are to be used. The installed SCS must carry a 25 year minimum warranty.

NOTE: The Structured Cabling System must be installed by an approved and certified contractor for the Structured Cabling System. The work cannot be awarded to an uncertified contractor and then subcontracted to a certified entity for testing in an attempt to meet the manufacturer's warranty requirements. The Contractor shall be responsible for workmanship and installation practices to ensure that the installation meets or exceeds the Structured Cabling System requirements and qualifies for the 25 year warranty.

- G. Cross connections and patches are the responsibility of OIT/CI after the completion of the required terminations by the Low Voltage Contractor. However, cross connections, patches, and corresponding documentation may be assigned to the Low Voltage Contractor on a case-by-case basis.
- H. Testing of all facilities in accordance with manufacturers' specifications.
- I. As-built diagrams for inside plant:
  - One paper copy posted in each OIT Room for corresponding floor(s).
  - One complete set (CAD/PDF format).
- J. As-built diagrams for outside plant:
  - One complete set (CAD/PDF format).

K. Manufacturer's 25 year warranty certificate.

**\* Please see related sections of this specification for details.**

### **3.2 OUTSIDE PLANT**

#### **General**

Install and route feeder cables using existing duct banks where possible. In the case of a new building or campus, duct banks will be incorporated into the design unless disallowed by Design and Construction Services. The duct banks will be buried to the prevailing code.

PLEASE NOTE: The primary communications conduits to the Main Building Distribution Room (MBDR) shall be encased in concrete with no more than two 90 degree bends in the duct bank. Duct banks with more than two 90 degree bends shall require adequate sized pull boxes or manholes to accommodate the duct bank's conduit quantities and to comply with the no more than two 90 degree bend standard. Conduit encased in concrete must transition from PVC to rigid metal conduit or collar (rigid EMT) and be grounded and bonded with nylon bushing .

Two feeder cables are required for each building, a main and a redundant. Pathways will be determined on a building by building basis. Feeder cable shall be housed in the appropriate number of 2 inch (2") or 4 inch (4") conduits with measure marked pull tape. Pull string is not acceptable in conduits outside of buildings. Cable passing under roads, parking lots, or other support surfaces must be in concrete encased, protective, rigid, waterproof, schedule 80 PVC conduit as per NEC Code. Schedule 40 is not allowed.

Locator tape shall be used as required by the National Electrical Code and provided by the Contractor for cable encased in duct banks, or any communication cable not encased in concrete. Conduits must be buried at a minimum depth of 30 inches (30") in a 34 inch (34") deep trench with locator tape above.

#### **Boxes: Manholes, Hand-holes, and Junction Boxes**

All pull boxes, splice boxes, and manholes must be approved for use by CI. Boxes should be traffic rated. **NO** plastic boxes are allowed. Installations must include the appropriate racking, sump, bolt down cover, and pulling eyes. Boxes and manholes must have a generic telephone emblem on the lid.

- A. All boxes must be placed in areas outside of vehicular traffic. The project engineer will specify the size and location of boxes. Man/handholes will be specified in areas that are exposed to vehicular traffic.
- B. Placement of boxes and manhole must allow for the final grade of new sidewalk and parkways.
- C. A minimum of six inches (6") of compacted sand, graded level is required under all pull boxes (hand-holes) and splice boxes. Six inches (6") of gravel, drain rock, or base rock is required for manholes. The floor must be level and free of debris.
- D. All conduits entering knockouts in a vehicle traffic rated box must be cut within one inch (1") of flush with the inside of the wall and sealed. All joints must be mortared and all unused ports and openings sealed. Use cement mortar, water plug cement or other FAU approved prepared mortars.

- E. Service conduits must be terminated above the main distribution conduits.
- F. ATT grounding in manholes/hand holes are determined by AT&T as needed per project.

### **3.3 CAMPUS INFRASTRUCTURE LAYOUTS**

#### **Boca Raton Campus**

No communications cable, neither fiber nor copper, shall be pulled in or removed from the tunnel system by a third party unless the pathway has been approved by CI and an OIT / Design and Construction Services representative is present.

All buildings require at least two independent, fiber optic feeder cables, a main and a redundant. The main fiber optic feeder cable shall be brought from the Operations Center in Building 22 through the tunnel system/duct bank to the service entrance of the building under construction or renovation. From there it shall be pulled into the building's MBDR and be protected with connectors and/or dust covers at both ends. The redundant fiber optic cable shall be brought from an alternate location to the building under construction using a diverse pathway. The paths of both the main and redundant feeder cables will be determined by CI during the design phase. All cables shall be installed in continuous lengths from origin to destination with no splices unless specifically agreed upon by the CI project manager.

All copper cable must be protected and terminated. Copper feeder cable shall be brought from Room 200 in Building 5 through the tunnel system, through the service entrance of the building under construction or renovation, into the building's MBDR, and must be protected with connectors and dust covers at both ends so no cable is open to the environment.

#### **Partner Campuses and Remote Sites**

Remaining FAU Campuses and remote sites may not have tunnel systems. Outside plant/feeder cables require a code-compliant duct bank system. However, all other specifications apply equally to all campuses and remote sites. All cables shall be installed in continuous lengths from origin to destination with no splices unless specifically agreed upon by the CI project manager.

### **3.4 OUTSIDE PLANT CABLING INFRASTRUCTURE**

#### **Fiber**

A minimum of 24 strands of single-mode (SM) fiber and an equivalent secondary/redundant route are to be installed from the MCDR to the location under construction or renovation.

#### **Video/Distance Learning**

Design and Construction Services in conjunction with CI will determine the size, quantity, and pathways of conduit that will house video OSP. The cable will be installed and terminated by the contractor providing cable television services at the time of installation. See the Instructional Technologies Specification (6.0), for further details.

## **Copper**

A minimum of 25 pairs OSP copper to each building is required.

Copper outside plant shall be 22/24 AWG, gel-filled PE-89 cable or manufacturer's equivalent if using another CI approved Structured Cabling System. **ALL** cabling infrastructure shall be properly grounded in accordance with current electrical code.

Terminate and protect all copper outside plant cable pairs at both ends, using splices for protector terminals and riser cables to patch panels or connector blocks. Cable terminations must be continuous with no "spare outs".

Copper outside plant cables will be protected with solid state, code-compliant protection devices on both ends by splicing feeder cable to "in" tail of protector and punching down or splicing "out" tail of protector to 110 blocks or riser cables. The type of protection or connector blocks used shall be determined by location, and space and only after discussion with CI.

Connections at all patch panels or frames are the responsibility of FAU OIT, after the completion of the required terminations by the Low Voltage Contractor. However, cross connections, patches, and corresponding documentation may be assigned to the Low Voltage Contractor on a case-by-case basis.

End User Room Terminations: Make telephone wire terminations to approved jack and outlets. Connect the telephone wire to one RJ45 jack on the faceplate in a four inch by two and one-eighth inch (4" x 2 1/8") outlet box.

### **3.5 BUILDING SERVICE ENTRANCE FACILITIES**

The Building Service Entrance penetrates the outside wall of the building's Main OIT Room and provides access for all OSP. The Service Entrance shall consist of a minimum of four, 4 inch (4") and two, 2 inch (2") conduits, protruding three inches (3") above floor level. Measure marked pull tape is to be used in all OSP conduits. The total quantity of conduits shall be determined on a project-by-project basis by FAU CI.

OIT entrance sleeves and sleeves between floors shall be four inch (4") metal rigid. Entrance facilities fire stops are the responsibility of the Electrical Contractor. Any conduit not used at the time of installation shall be capped or fire stopped as location requires.

Solid state surge protection is required for all cables and outside outlets supporting OIT equipment, splices, terminations, punch downs of all copper and fiber cable terminations, no matter where located.

Fire stops for conduit not included in the original scope of the project and installed by the Low Voltage Contractor are the responsibility of the Low Voltage Contractor.

See Section 3.14, OIT Requirements for Electrical Contractor, for additional grounding/bonding requirements.

## 3.6 OIT ROOMS

### Overview and Definition

There are three types of OIT Rooms indicated below. Any OIT Room containing a router must also be equipped with a non-FAU analog line for data maintenance. Note: On partner and joint use campuses, OIT will have a minimum of one data router per campus, located in the MCDR and the appropriate number of data switches in individual buildings. For typical layouts and rack elevation, see Section 5.2, Appendix B: OIT Room Layouts and Rack Elevation. All Rooms shall be environmentally controlled, dust free and secure. Each room shall also contain a *dry fire suppressant system*.

### Main Campus Distribution Room/MCDR

A one per campus minimum, no smaller than twenty by twenty five feet (20' x 25') containing the primary voice and data equipment and facilities for the campus. This room shall be centrally located and used only by OIT and LEC/CLECs. Construction of this facility should be necessary only when a new single or multi-building campus is created.

### Main Building Distribution Room/MBDR

A one per building minimum, no smaller than twelve by fourteen feet (12' x 14') containing the Building Service Entrance as well as voice/data and video equipment. This room shall be for the use of OIT and LEC/CLECs only, centrally located, and shall be no more than two hundred ninety two (292) cable feet from the farthest data device. All OIT Rooms shall be stacked above the Main OIT Room. The Main Room should be sized sufficiently to also serve as the IDR for the floor on which it is located.

### Intermediary Distribution Room/IDR

A minimum of one per floor, no smaller than twelve by fourteen feet (12'x14') that contains voice/data/video riser terminations and/or pass throughs, cross-connect terminals, and surge protection devices. These locations shall be for the use of OIT and LEC/CLECs only. IDRs shall be stacked vertically above the MCDR or MBDR and be no more that two hundred ninety two (292) cable feet from the farthest data device.

### Room Locations

All OIT Rooms are to be located as close to the center of the building as possible to comply with infrastructure distance limitations. IDRs are to be stacked above the MCDR or MBDR. Rooms shall not be located adjacent to electrical rooms, near any source of water nor used as a pass-through for pipes containing water.

### OIT Room Construction Requirements

In addition to the requirements listed below see Section 5.2, Appendix B: OIT Room Layouts and Rack Elevation. Each room requires:

- A. All walls without windows to have three-quarter inch ( $\frac{3}{4}$ " ) thick, eight foot (8') by four foot (4') plywood backboards, vertically mounted no lower than two inches (2") above the floor painted network gray with fire retardant paint and mounted in such a way as to support telephone terminals, cables, and other equipment weights as agreed to by OIT. Walls having doors shall meet the above requirements with the widths being adjusted to accommodate the door.
- B. No ceiling grid and a ceiling height of at least 8' 6" to permit the vertical mounting of the

backboards where required.

- C. Wall mounted equipment on the communications board is to be mounted with the top no more than 6 feet (6') above floor level.
- D. A minimum thirty six inches (36") wide by eighty four (84") tall, locked door for personnel entry which swings outward to provide maximum usable wall/floor space and is code compliant.
- E. The walls and ceilings painted a light color latex paint with the floors tiled or sealed to keep dust at a minimum.
- F. All conduit, pathways, raceways, sleeves and cable trays to be grounded via a #6 solid insulated ground conductor.
- G. All communications equipment on generator backup per CI specifications.
- H. OIT Room lighting must illuminate both sides of data racks. Check orientation of lights to racks. At least one light must be on emergency generator power. See Section 5.2, Appendix B: OIT Room Layouts and Rack Elevation, for light orientation.
- I. No ceiling tiles are to be installed in order to facilitate initial and on-going cabling.
- J. MCDR and MBDR Rooms shall have ladder racks around the perimeter and from the perimeter to the data rack(s). Data rack style and configuration are determined on a room-by-room basis by CI.
- K. OIT Rooms require a minimum clear work space of thirty-six inches (36") on both front and back sides of racks.
- L. See Section 3.14 OIT Requirements for Electrical Contractor, and Section 5.4 Appendix D: Grounding and Bonding for grounding requirements.

### **OIT Room Environmental Requirements**

Each MCDR shall contain the primary/main telephone and data communications facilities, located as close as possible to the building risers and OIT Rooms, where electro-magnetic interference is minimal. It shall be located on the first/main floor, and can house building entrance cable splice and surge protection.

Central air conditioning ducts shall be installed to each OIT Room. In addition, dedicated air conditioning is required where any OIT voice and/or data equipment is located. The support unit shall be on the building backup power generator system with automatic access during periods of power failure. The location will be determined in coordination with OIT on a case-by-case basis.

The air conditioning system shall provide a minimum support of 48,000 BTUs for MCDRs and 24,000 for all other Rooms, not including any extra units. The Room temperature must be maintained at or below 75 degrees Fahrenheit with humidity at or below 50% after all equipment is installed and on line. Positive air flow is needed in all OIT Rooms. Please contact CI for Boca Raton Building 5 exceptions.

Each OIT Room must contain a carbon dioxide fire extinguisher, and where sprinklers are required, high temperature (250 degrees Fahrenheit) sprinkler heads, and smoke detectors, shall be installed.

### **Fiber Terminations**

- A. Feeder cable shall extend from the Service Entrance to the bottom of the wall space designated for mounting the data communications backboard or the voice panels.
- B. All feeder cable shall terminate on patch panels.
- C. Install one rack-mounted fiber optic interconnect enclosure.

### **Copper Terminations**

- A. Install wall-mounted equipment on the appropriate backboard with the top of the Connector blocks at no more than five feet (5') above floor level.
- B. All ISP cabling infrastructure is to be installed using "plug-and-play". However, should OIT have previously given permission to terminate cable on 66M 150 blocks. The contractor shall run all station wires on backboard at the outer edge of board, down or up, as appropriate, then across and up from the bottom to the 66M 150 blocks mounted on a 89B bracket with #8 x ¾" Philips screws in mounting ears, not in the center of bracket.
- C. The quantity of voice/data patch panels shall be determined by Communication Services Infrastructure on a case-by-case basis.
- D. For data, rack-mount all Patch Panels. For retrofits only and where space is limited, OIT will consider wall-mounted racks on hinged wall brackets on the data communications backboard. Wall-mounted data equipment shall be mounted on the backboard. Quantity of patch panels shall be determined by CI.
- E. Conduits from the cable tray to the MBDR (for internal riser and distribution cable) shall consist of four 4inch (4") grounded and bonded conduits.
- F. See Section 3.14. OIT Requirements for Electrical Contractor for grounding requirements.

### **OIT Room Hardware Requirements**

- A. 19" racks for data equipment. Number of points and enclosures are determined on a case-by-case basis.
- B. Patch panels with approved Cat 5e/6/6a patch cables for voice and data.
- C. Rack Organizer System.
- D. 19" rack-mounted 48 port fiber optic enclosure box, high-density LC connector panels.
- E. Rack-Mountable Interconnect Center, Connector Panel Modules.
- F. Patch panels: rack mounted in accordance with the configuration of the Room as determined by OIT. 19" rack-mountable Cat 6/6a 110 Patch Panel in appropriate size.
- G. Cat 6 or 6a patch cables (Room and user end).
- H. 110 Connect Patch Panel for data room terminations.



- I. Install Patch Panels, rack mounted or mounted on hinged wall brackets on the appropriate backboard, if space does not allow for a rack. Quantity of patch panels shall be determined by CI.
- J. Room Terminations for voice: make OIT Room terminations for voice to approved patch panels for plug and play.

### 3.7 RISER CABLE

The building riser shall consist of a minimum of one 24 strand single mode fiber optic cable and 6 Cat 6a copper cables between each IDR. Risers are to be installed as a single uncut cable between the MBDR that contains the Building Service Entrance and the IDR leaving a 24 foot (24') slack service loop at each end. If Rooms are within EIA/TIA specifications for Enhanced Category 6/6a length, install one 25 pair uncut riser cable between the MBDR and the IDRs containing data switches. Terminate on the cable appropriate patch panel.

### 3.8 HORIZONTAL CABLE

- A. Horizontal cabling shall be extended from each OIT Room via basket-type cable tray with side-saddles located above the ceiling in the corridors. Cable tray is not to be shared with any non-OIT low or high voltage cabling. Reminder: One (1") inch thin wall conduit (EMT *not* flex) with pull string will be extended from within six (6") to twelve (12") inches of the cable tray to the outlet boxes. Wall outlet boxes shall be 4-inch square, 1-1/2 inches deep with single-gang trim rings and mounted vertically. Specifications for and locations of floor/ceiling boxes will be determined by OIT during the project's design phase.

OIT Rooms Grounding System: The ground bus bar shall be a minimum of ten by four inches (10"x4") ¼ solid copper, mounted to the using insulated standoffs. The ground bar must be connected to the main service ground via #4/0 insulated ground conductor. The ground bar must be bonded to the building steel (NOT piping) via #6 insulated solid conductor. All cable trays, race ways, racks, etc. must be grounded via #6 copper wire.

All conduits/raceway systems must have pull string/tape.

Any and all deviations from prints or any value engineering must be approved by CI in writing.

- B. Cable Terminations: Each Structured Cabling System (SCS) communication receptacle/faceplate shall be populated with three SCS cables terminated on SCS RJ45 jacks. All ISP for video is pulled by the Low Voltage Contractor in conjunction with the SCS cable. Each conduit to the faceplate shall also hold one pull string. In the OIT Room, the SCS cables shall be terminated on category appropriate patch panels. The modular face plate shall be a four-port, almond faceplate configured with three RJ45 jacks and one blank. Orange jacks are used for ports designated for video.
- C. Code: All inside cable/wiring and installation must be code compliant and plenum rated.

- D. Other SC Systems: OIT will consider other structured cabling systems, on a case-by-case basis, if they are manufactured by a single company and sourced through a single vendor or in a partnership with a written contract that extends through the duration of the warranty. A single point of customer contact must be provided for on-going maintenance and supply issues. The product specifications must be equal to or exceed the current industry ANSI/TIA/EIA, ISO/IEC, IEEE standards and carry a twenty-five (25) year warranty. In the case of partnerships the vendors must show, in writing, end-to-end engineering and testing results as well as partnership documents that verify equal or better the life of the system warranty.

### 3.9 WIRELESS

- A. The manufacturer and model number for wireless enclosures/antennas installed above dropped ceilings are determined on a project-by-project basis by CI Networking in conjunction with Design and Construction Services. In the case of a renovation, a joint walk-through may be required. All enclosures are to be locked with FAU keyed locks. WAP locations are determined by OIT. External access point locations require two one-inch (1") sleeves to the outside and lightning/surge protection. See exterior detail specification diagram in Section 5.3, Appendix C: Wireless Access Points.
- B. Enclosures, access points, and jacks are to be labeled according to network documentation standards as described in Section 3.11, Labeling. The enclosure is to be labeled outside with jack and access point designation. If a power injector is used it is to be labeled with the WAP name, jack, and switch/blade/port. Power injectors are to be neatly secured together with Velcro in an accessible location and completely patched through from the equipment to the Cisco switch. All label printing will be machine generated (hand written labels are not acceptable.)
- C. Outside access points are to have lightning protection and code-compliant grounding. The grounding point can be no further than twelve inches (12") from the WAP and is the responsibility of the Electrical Contractor.
- D. All external wall penetrations are to be sealed.
- E. All external antennas are to be rated for external use. Non-metallic exterior paint that matches the building's exterior may be required. TapCon screws are to be used to secure the antenna to the wall.
- F. All WAP connections, including console, ports and power injectors are to be completely patched through from end-to-end.
- G. Three cable drops of SCS appropriate cable with both cables patched through to the access point. The first cable will be connected to the Ethernet port and the second cable to the console port.
- H. A surge protected power strip must be included in the deployment and used for the power injectors.
- I. Antenna model and type are to be approved by CI Networking.
- J. Conduit for external antenna must consist of two, one inch (1") conduits mounted horizontally. The distance between conduits shall be determined by OIT, based on antenna model.
- K. In accessible ceilings conduit from the junction box to the cable tray is to be installed according to the OIT specifications presented in this document.

### 3.10 ADDITIONAL APPLICATIONS

- A. **Elevator Phones:** Each elevator shall be equipped with one independent, non-looped, conduit encased telephone line supplied and installed by the Elevator Contractor. The conduit will run from the OIT Room to the appropriate, code-compliant location near the elevator equipment terminated outside the elevator equipment panel in a single gang wall or flush mounted device box. A conduit stubbed from this location shall be installed to a knockout on the elevator control panel for a patch cord to be run by the elevator mechanic. The telephone line shall be completely wired and cabled back to the nearest MBDR/IDR. Termination of the elevator equipment is the responsibility of the elevator company. OIT will provide a demarc in the elevator company's equipment room. Connection from the demarc to the OIT Room is OIT's responsibility.
- B. **Courtesy Phones:** Quantities and locations to be determined by building owner in accordance with OIT Specification standards.
- C. **External Security Devices:** Devices such as security cameras require ¾ inch (3/4") conduit and lightning/surge protection. Locations are to be determined by the FAU Police Department. Card readers, card reader access locations, emergency blue lights, fire alarms, and lockdown systems require conduit as provided for in this specification. Equipment supporting security equipment shall not be located in any OIT Room. The Low Voltage Contractor will install the cable to the appropriate location.
- D. **Classrooms:** See Section 6.0, Instructional Technologies Specifications, for requirements.
- E. **Exterior Data Connections:** A demarc in a waterproof box is required for all exterior data connections.
- F. **Floor Jacks and Raised Floors:** The Electrical Contractor must provide details of types of jacks and raceways being provided. Cable trays are required under raised floors. Separate raceways/cable trays must be provided for high and low voltage infrastructure. The Electrical Contractor must provide an approved cover plate. Pedestals and trays for raised floors must be grounded.
- H. **Emergency Phones with Pedestals:** All lines must be encased in conduit to avoid interference. Conduit is to be installed into the equipment and cabling must run to the top of the pedestal to facilitate phone installation and maintenance.
- I. **Data Centers and Server Rooms:** Design will be done on a project-by-project basis and all infrastructure shall be installed in accordance with the OIT Specification.
- J. **Card Readers:** Quantities and locations will be determined by the FAU Police Department. OIT will oversee the installation of the cabling infrastructure. The location of the card reader control panel must be approved by CI.
- K. **Security Cameras:** Quantities and locations will be determined by the FAU Public Safety Department. OIT will oversee the installation of the cabling infrastructure.

### 3.11 LABELING

Numerically marked non-conductive location tags shall be provided at all OIT Room cable terminations to ensure positive identification for cable/wire routes. Faceplates shall also be labeled front and top using the FAU/OIT numbering scheme. All label printing will be machine generated (hand written labels are not acceptable.)

#### Standard Labels

The jacks in each OIT Room start with a capital letter. Each OIT Room in a building will have a unique letter. For example, jacks in the first floor OIT Room will start with the letter "A". Those in the second floor OIT Room will start with "B" etc. Letters that denote location such as N, S or E, W may be used. However, each OIT Room in a building must have a unique identifying letter.

CI is responsible for ensuring that each OIT Room is assigned a unique letter and advising contractors/vendors of the same. Sample jack numbers:

A1001, A1002, A1003, etc. (first floor communications room)

B1001, B1002, B1003, etc. (second floor communications room)

Jack labels for cables located in the ceiling should be appended with the letter "C" for ceiling. These cables are commonly installed for wireless access points, security cameras, projectors, etc. An example of a sample label would be N1025C.

#### WAP Labels

WAP label/name AAABCCRRRapJJJJJ

A= Campus (boc,dav,jup,sea,pj,hb)

B= Building Number

C= Building Code

R= Building Room

ap = Access Point

J = Jack Number

Example : WAP located in Boca Campus building 22 room 160 jack N1234C = boc22cm160apN1234C

### **3.12 CODE REFERENCES**

Florida Atlantic University promotes the use of widely accepted industry standards in deploying the University communication infrastructure. Employees of the University, consultants, and contractors working on behalf of the University should have a working knowledge of these standards prior to performing work for the University and should follow the University preferred standards and practices while deploying communication infrastructure. University employees, consultants, and contractors should contact CI for clarification and interpretation of these standards.

FAU's communications systems shall be built in accordance with the codes and standards set forth in the following: NEC, NESC, NFPA, ANSI/TIA/EIA Telecommunications Building Wiring Standards, FCC, IEEE and BICSI's Telecommunications Distribution Methods Manual. These codes and standards are to be used as references when designing communication infrastructures. Use of the most recent standard is required.

### 3.13 OIT REQUIREMENTS FOR ARCHITECT/ENGINEER

#### Drawings

Drawings must show responses to OIT comments as well as symbols and/or notations for:

- A. Building risers and conduit or tray wall penetration into OIT Rooms, fire stops and bonding.
- B. All conduits from outlets.
- C. All outlets must come from emergency generator power.
- D. All outlets must have isolated ground as per NEC code.
- E. Each outlet requires a separate circuit.
- F. Breaker panel on emergency generator power.
- G. Copper ground bus bar per current electrical code.
- H. Man/handhole details and cross sections of all ductbanks.
- I. Wireless: Show jacks/WAPS on electrical systems sheets. Location to be determined/provided by OIT.
- J. Elevator/HVAC control unit conduit shall be shown.
- K. Raised floors: pedestals and trays must be shown.
- L. Conduit for all network-related security and mechanical devices shall be shown.
- M. All OIT Rooms should also show the following (exact outlet locations and quantities are project dependent and will be determined by OIT.)
- N. OIT Rooms Electrical

IMPORTANT: One dedicated circuit per quad receptacle is required for all OIT electrical installations.

#### General Use:

Three quad 120 volt, 20 amp isolated ground power outlets with offset faceplates  
Two quad 120 volt, 20 amp isolated ground power outlets on data racks

OIT Rooms Electrical for Switches- Each Network Switch requires:

Four L6-20 outlets behind the data switch rack. Location to be determined by OIT. One

L6-30 outlet on the wall behind the data switch rack. Location determined by OIT.

OIT Rooms Electrical for Voice Shelf- Each Telecommunications IPDA Shelf in the MCDR/MBDR requires:

One L6-30 outlet on the telecommunications rack. Location to be determined by OIT.

See Appendix B, Section 5.2, OIT Room Layouts and Rack Elevation for diagrams.

### **3.14 OIT REQUIREMENTS FOR ELECTRICAL CONTRACTOR**

Conduit/Cable Tray: **No** Flex conduit/Greenfield or J-hooks are to be used on new construction or renovations. All internal conduits must have pull strings. All external conduits must have pull capable measuring tape.

"Flex Tray" brand or welded, unpainted, wire mesh cable tray is required for all installations. Size: two by twenty four inches (2" x 24") unless otherwise authorized by OIT. All trays are to be grounded and bonded to each other and to the building ground.

Outside plant entrance facilities (standard configuration): minimum of two, 4 inch (4") and four, 2 inch (2"). Any and all changes to be determined by OIT based on needs of the building and the master plan.

NOTE: Conduit encased in concrete must transition from PVC to rigid metal conduit or collar (rigid EMT) and be grounded and bonded with nylon bushing .

Risers for buildings with 3 or more stories must include riser conduit/sleeving for copper and fiber to each OIT Room with a minimum of three, 4 inch (4") and three, 2 inch (2"). Note: AT&T requires rigid conduit and a junction box at the demarcation location on all installations above the first floor.

Cable tray for non-solid ceiling construction will be terminated inside the OIT Room. If the tray does not penetrate the room a minimum of four, 4 inch (4") horizontal conduits/sleeves will be used, with OIT determining the final quantity.

All conduit, raceway, cable tray, and data racks must be grounded via #6 solid insulated ground conductor.

OIT requires heavy wall Schedule 80 PVC, or current code, for underground conduit and rigid metal inserts at building entrance.

Conduits in concrete slabs must be a minimum of one and one half inches (1 and 1/2") in diameter.

The size of all conduits running to the faceplates shall be 1 inch (1"). This applies primarily to conduit from the outlet to the cable tray, OIT Room, fire alarm, elevator equipment cabinet, pay phones, mechanical room, or for AT&T applications. Conduits shall extend to within 6" to 12" of the cable tray and be grounded and bonded to (not in) the cable tray.

Cable runs for data applications must be no longer than 292 feet (292') from outlet to switch.

Courtesy phone outlets and conduits shall be shown on drawings and terminate in a drop mounted fixture in accordance with ADA requirements.

Floor Jacks and Raised Floors: Electrical Contractor must provide details of types of jacks and raceways being provided. Cable trays are required under raised floors. Separate raceways/cable trays must be provided for high and low voltage infrastructure. The Electrical Contractor must provide an approved cover plate. Pedestals and trays for raised floors must be grounded.

#### **Grounding Requirements:**

All trays, risers, and conduits within and between buildings, raceways, and sleeving must be grounded.

#### **Dedicated Electrical Circuits**

One dedicated electrical circuit per quad is mandatory.

**OIT Room Minimal Power Requirements:**

Three quad outlets with common cover, isolated ground receptacle 20-amp, 120 volt with one located on each plywood backboard. Two quads with common cover, isolated ground receptacle 20 amp 120 volt located on top of the data rack.

Four special-purpose isolated ground receptacles, 20 amp, 250 volt, 2 pole, 3 wires twist lock (NEMA L6 20R) with location to be determined by CI.

One special purpose isolated ground receptacle, 30 amp, 250 volt, 2 pole, 3 wires twist lock (NEMA L6 30R) with location to be determined by CI.

All electrical receptacles must be isolated ground receptacles and installed in accordance with the manufacturer's written instructions and in compliance with NEC requirements.

All electrical receptacles and light fixtures must be connected to the building's emergency electrical panel.

All electrical receptacles shall be properly labeled, indicating the electrical panel ID, circuit breaker number, and number of the room in which the electrical panel is located.

OIT Room grounding requires a ground bar that is minimally 10" x 4" solid copper, mounted to the wall using insulated standoffs. The ground bar must be connected to the main service ground via #4/0 insulated ground conductor. Ground bar must be bonded to the building ground via #6 insulated solid copper wire. Grounding to water pipes is not acceptable and, if installed, shall require correction.

See also Section 5.0, Appendix B: OIT Room Layouts and Rack Elevation for typical OIT Room layouts and Section 3.13N.



## **4.0 LOGISTICS**

### **Material Storage**

FAU has very limited storage space and the Low Voltage Contractor/vendor is required to store the bulk of the infrastructure in a readily available off-site location. CI grants exceptions on a case-by-case basis and as space permits.

### **Clean-Up**

Contractors are required to leave all FAU locations in the same or better condition as found upon arrival. Failure to do so will result in the contractor returning to complete clean-up at their own expense.

### **On-Site Parking**

Parking permits are required on all FAU Campuses and require a letter from the department with which the contractor or vendor is working. Permits for vans or larger vehicles must be obtained at Traffic and Parking on the Boca Raton Campus. Tickets are given for parking in unauthorized locations. For further information call 561-297-2771.

### **FAU University Security**

FAU security police are State of Florida police. Vendor information is given to the FAU Police Department to allow after-hours access as deemed appropriate by OIT. Unauthorized access issues are resolved by the FAU Police. The FAU Police can be reached at 561-297-3500.

### **Site Access**

Site access is scheduled in conjunction with Design and Construction Services project schedule. All contractors are required to notify/sign in with CI before attempting to access a project site. Escorted, off-hour and weekend access are provided by FAU Police. Access will only be given to vendors or contractors whose names CI has provided to the FAU Police Department.

### **Accidents**

All accidents must be reported *immediately* to the FAU Police Department at 561-297-3500.

## 5.0 APPENDICES

5.1 APPENDIX A: CHANGE ORDER/VARIANCE REQUEST FORM .....	23
5.2 APPENDIX B: OIT ROOM LAYOUTS AND RACK ELEVATIONS .....	24
B-1: Main Campus Distribution Room.....	25
B-2: Main Building Distribution Room.....	26
B-3: Intermediary Distribution Room.....	27
B-4: Rack Elevations.....	28
5.3 APPENDIX C: WIRELESS ACCESS POINT .....	29
5.4 APPENDIX D: GROUNDING AND BONDING .....	30

# 5.1 APPENDIX A: CHANGE ORDER/VARIANCE REQUEST FORM

## OIT Communication Infrastructure

### Change Order/Variance Request Form

To request a deviation from the OIT CI Specification, submit a completed copy of this form to CI. CI will coordinate the review of the request with Design and Construction Services Project Manager and respond in writing within five business days.

Any deviation undertaken by any contractor without the written approval of CI will be done at the contractor's risk and expense.

Project Number \_\_\_\_\_ Date \_\_\_\_\_

Contractor Representative \_\_\_\_\_

Requesting Agency \_\_\_\_\_

Change Order/Variance Requested:

---

---

---

---

---

Reason for Request:

---

---

---

---

CI Response:

---

---

---

---

Authorizing Signature: \_\_\_\_\_

Date: \_\_\_\_\_

## **5.2 APPENDIX B: OIT ROOM LAYOUTS AND RACK ELEVATION**

**B-1: Main Campus Distribution Room**

**B-2: Main Building Distribution Room**

**B-3: Intermediate Distribution Room**

**B-4: Rack Elevations**

## 5.2 APPENDIX B-1: Main Campus Distribution Room

### FAU Main Campus Distribution Room (MCDR)

#### Typical Layout - Top Down View

Please see FAU CSI Project Manager for latest revision  
 Final layout must be approved by IRM Project Management  
 Revision 2010-08-04

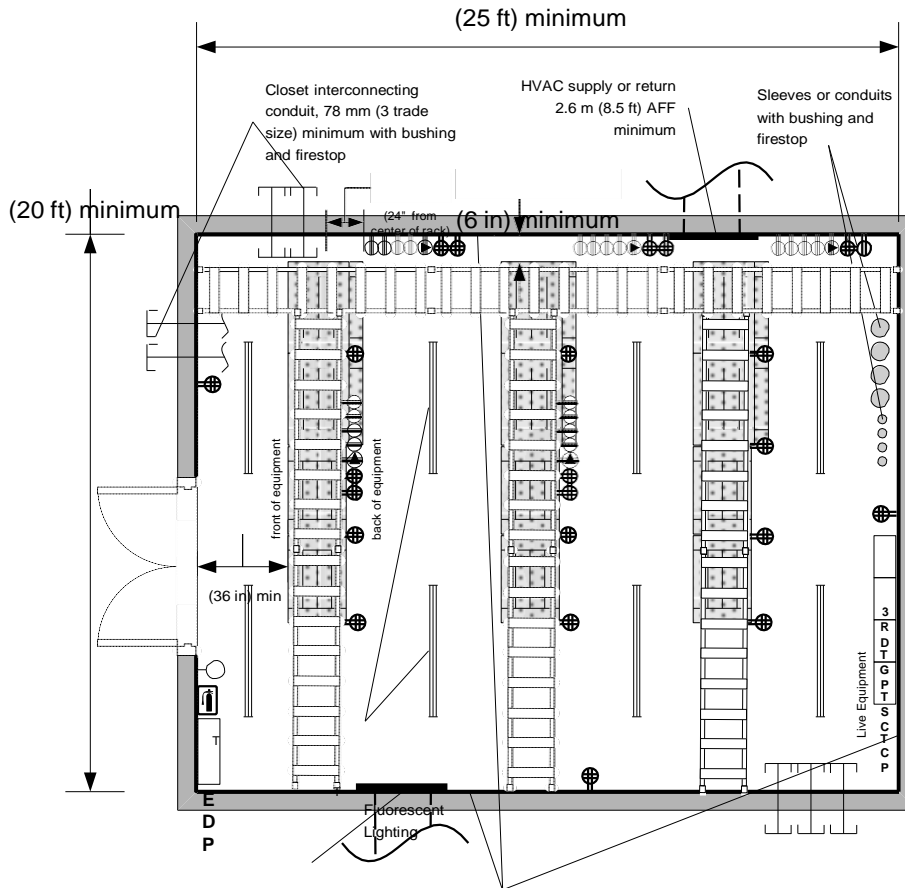

HVAC supply or return 2.6 m  
 (8.5 ft) AFF minimum

(¼ trade size) plywood  
 backboard all walls

- All electrical outlets must come from emergency generator power.
- Each receptacle or quad requires a separate circuit.
- All outlets must be properly labeled with a designation for standby power along with the unique circuit identification #.
- All electrical outlets must have isolated ground.
- Racks must be properly grounded.

	Double duplex NEMA 5-20	Quantity = 23
	L6-20	Quantity = 20
	L6-30	Quantity = 5
	Thermostat	
EDP	Electrical Distribution Panel	
TGP	Telecommunications Grounding Busbar	
TCP	Telecommunications Circuit Protection	
TSC	Telecommunications Splice Case	
AFF	Above Finished Floor	
HVAC	Heating, ventilating, and Air Conditioning	
3RD	Third Party Equipment	

## 5.2 APPENDIX B-2: Main Building Distribution Room

### FAU Main Building Distribution Room (MBDR)

#### Typical Layout - Top Down View

One data switch (375 connections) per room  
 Please see FAU CSI Project Manager for latest revision  
 Final layout must be approved by IRM Project Management  
 Revision 2010-08-04

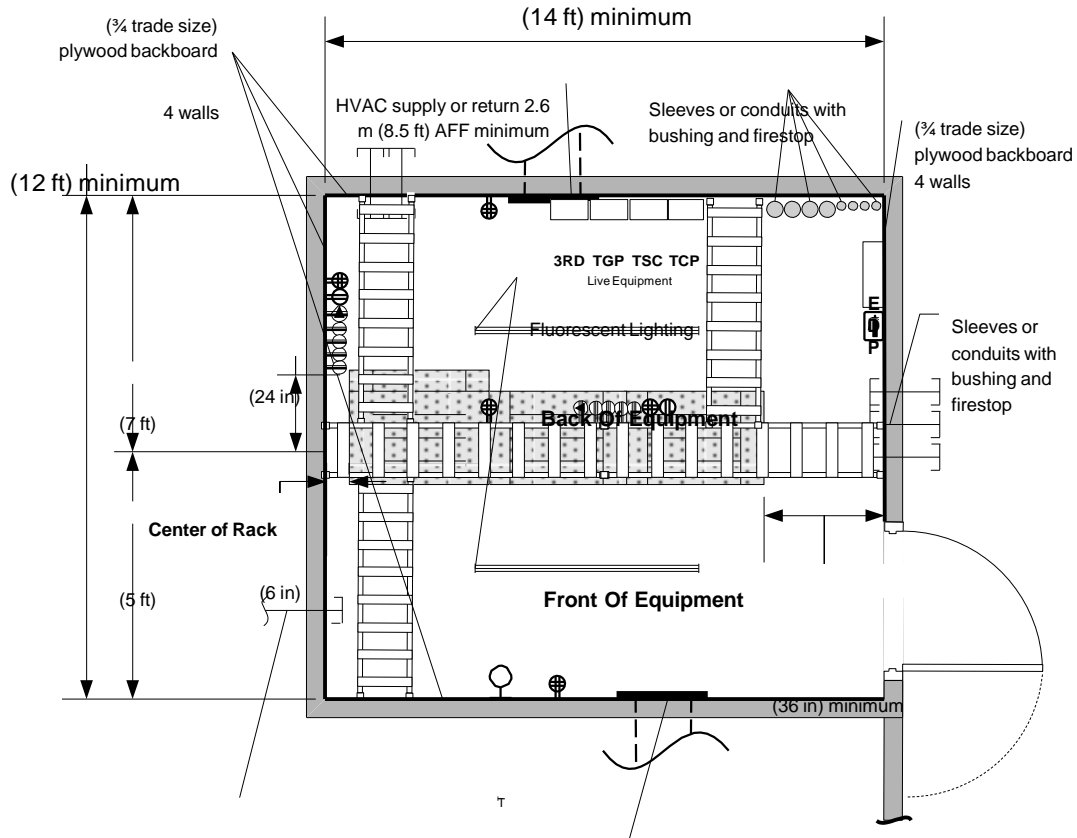

Closet interconnecting  
 conduit, 78 mm (3 trade  
 size) minimum with  
 bushing and firestop

HVAC supply or return  
 2.6 m (8.5 ft) AFF  
 minimum

- All electrical outlets must come from emergency generator power.
- Each receptacle or quad requires a separate circuit.
- All outlets must be properly labeled with a designation for standby power along with the unique circuit identification #.
- All electrical outlets must have isolated ground.
- Racks must be properly grounded.

	Double duplex NEMA 5-20	Quantity = 7
	L6-20	Quantity = 8
	L6-30	Quantity = 2
	Thermostat	
EDP	Electrical Distribution Panel	
TGP	Telecommunications Grounding Busbar	
TCP	Telecommunications Circuit Protection	
TSC	Telecommunications Splice Case	
AFF	Above Finished Floor	
HVAC	Heating, ventilating, and Air Conditioning	
3RD	Third Party Equipment	

## 5.2 APPENDIX B-3: Intermediate Distribution Room



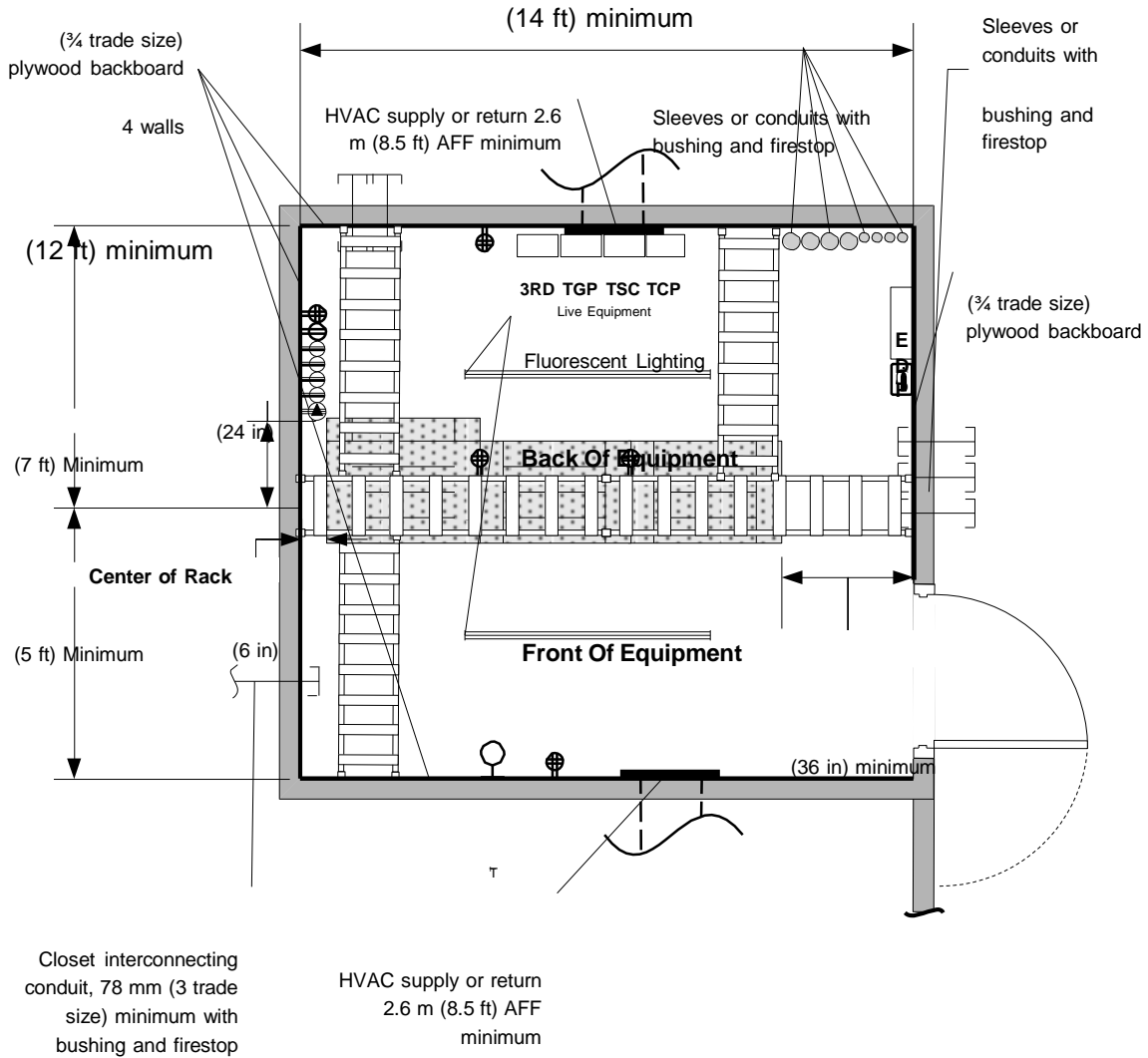

### FAU Intermediate Distribution Room (IDR)

#### Typical Layout – Top Down View

One data switch (375 connections) per room  
 Please see FAU CSI Project Manager for latest revision  
 Final layout must be approved by IRM Project Management  
 Revision 2010-08-04



- **All electrical outlets must come from standby generator power.**
- **Each receptacle or quad requires a separate circuit.**
- **All outlets must be properly labeled with A designation for standby generator power followed by the circuit identification information.**
- **All electrical outlets must have isolated ground.**
- **Racks must be properly grounded.**

	Double duplex NEMA 5-20	Quantity = 6
	L6-20	Quantity = 4
	L6-30	Quantity = 1
	Thermostat	
EDP	Electrical Distribution Panel	
TGP	Telecommunications Grounding Busbar	
TCP	Telecommunications Circuit Protection	
TSC	Telecommunications Splice Case	
AFF	Above Finished Floor	
HVAC	Heating, ventilating, and Air Conditioning	
3RD	Third Party Equipment	



## 5.2 APPENDIX B-4: Rack Elevations

### FAU Rack Elevation

Typical Layout - Front View

Please see FAU CSI Project Manager for latest revision  
Last Updated: Friday, August 13, 2010

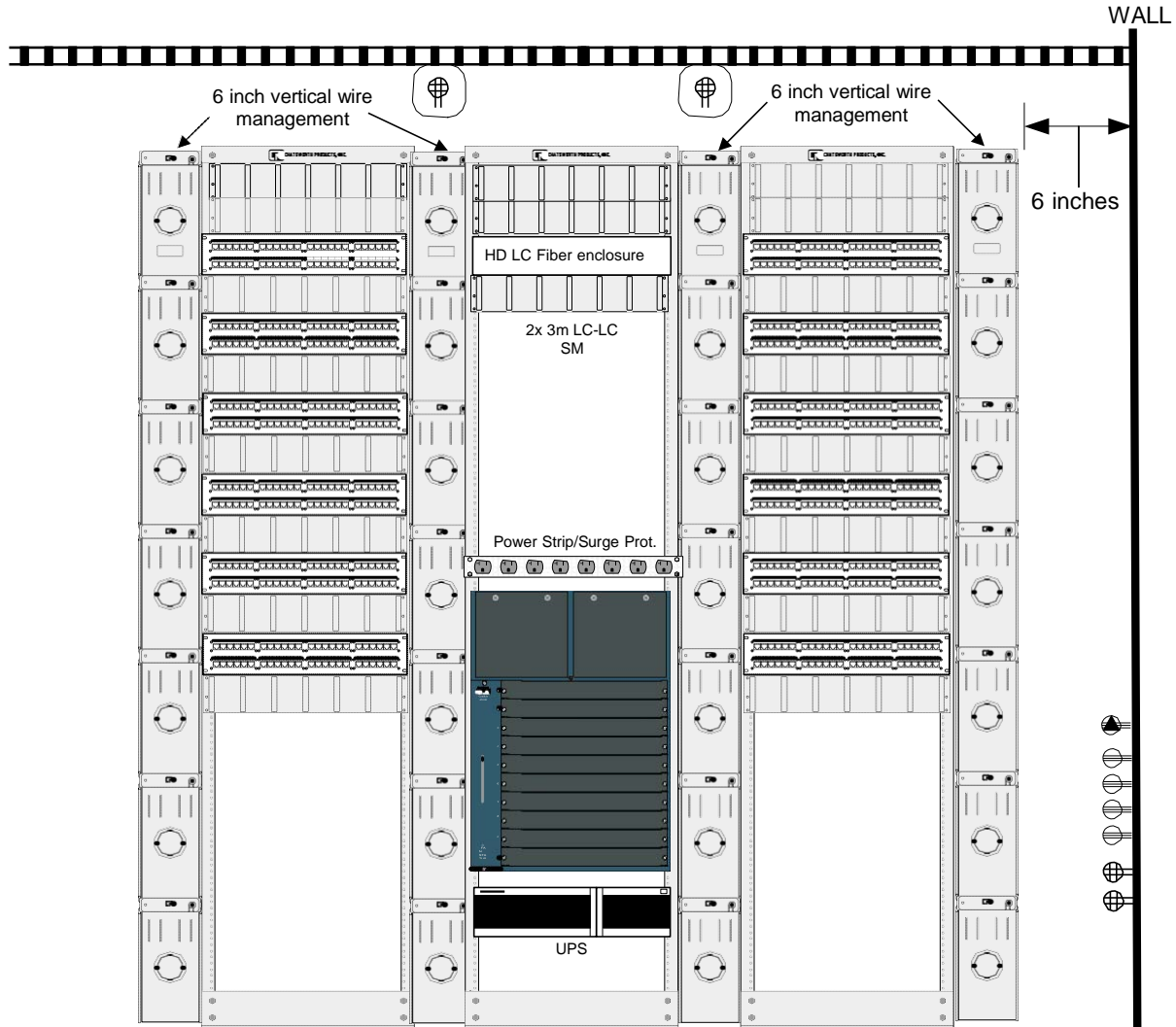

Number of racks, patch panels, and switches may vary due to capacity.  
Receptacle quantity will vary depending on cable count and switch count  
(375 Maximum data connections for three rack setup)

- All electrical outlets must have isolated ground.
- All electrical outlets must come from standby generator power.
- Each receptacle or quad requires a separate circuit.
- All outlets must be properly labeled with a designation for standby power along with the unique circuit identification #.
- Racks must be properly grounded.

#### Receptacle type and quantity per switch ..... ( )

- ⊕ Double duplex NEMA 5-20 120v ..... (4)
- ⊖ L6-20R (208v NEMA twist lock receptacle) ..... (4)
- ⊙ L6-30R (208v NEMA twist lock receptacle) ..... (1)

## 5.3 APPENDIX C: WIRELESS ACCESS POINT

### Typical Wireless Access Point (WAP) Detail

Please see FAU CSI Project Manager for latest revision  
Last Updated: Friday, August 13, 2010

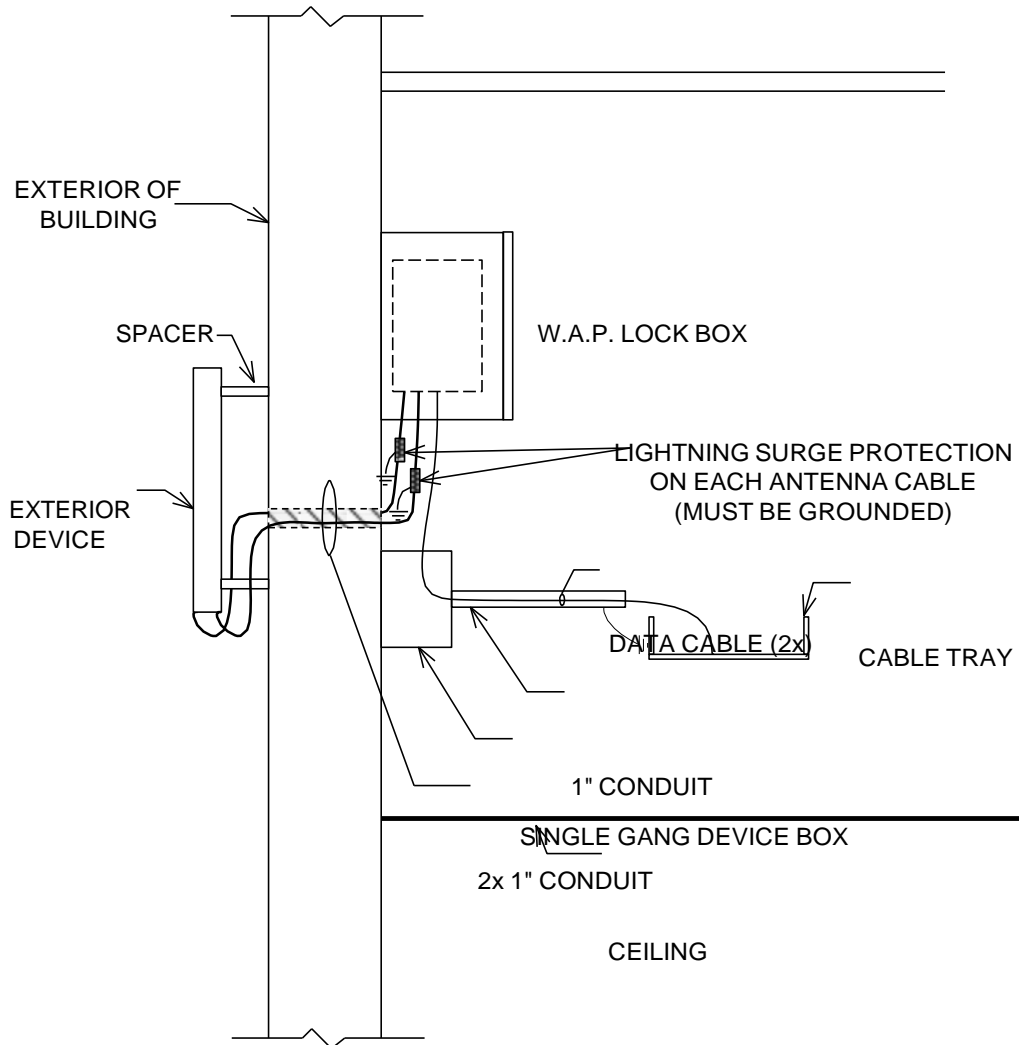

## 5.4 APPENDIX D: GROUNDING AND BONDING

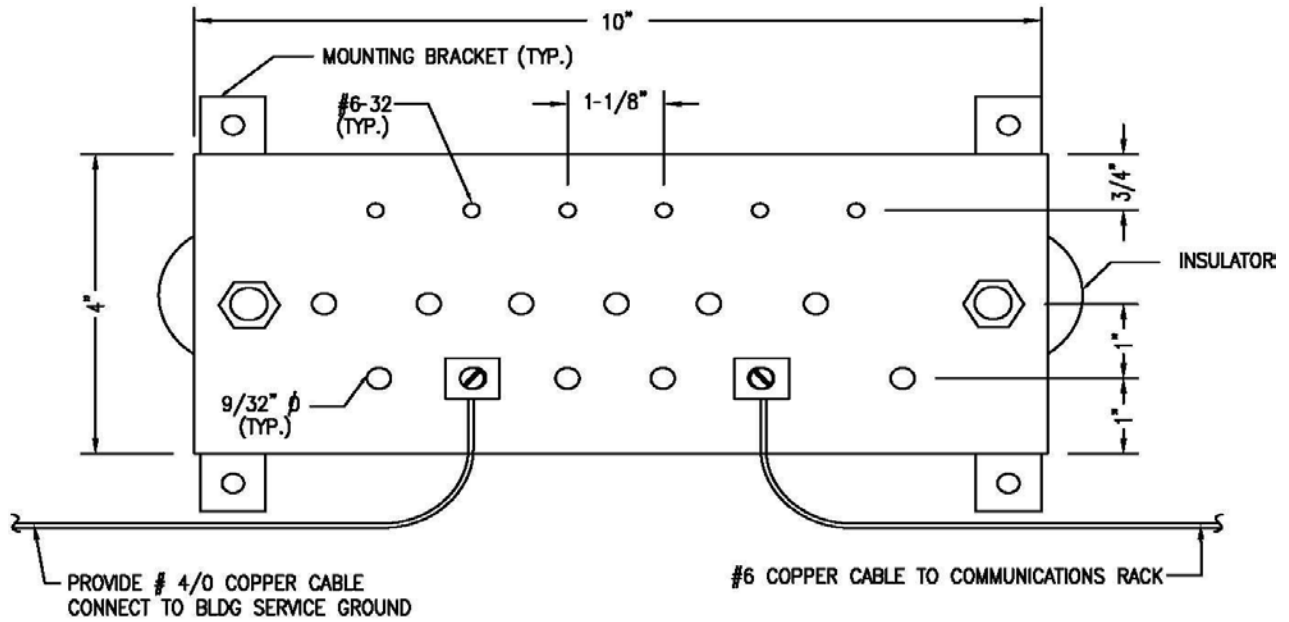

FRONT VIEW

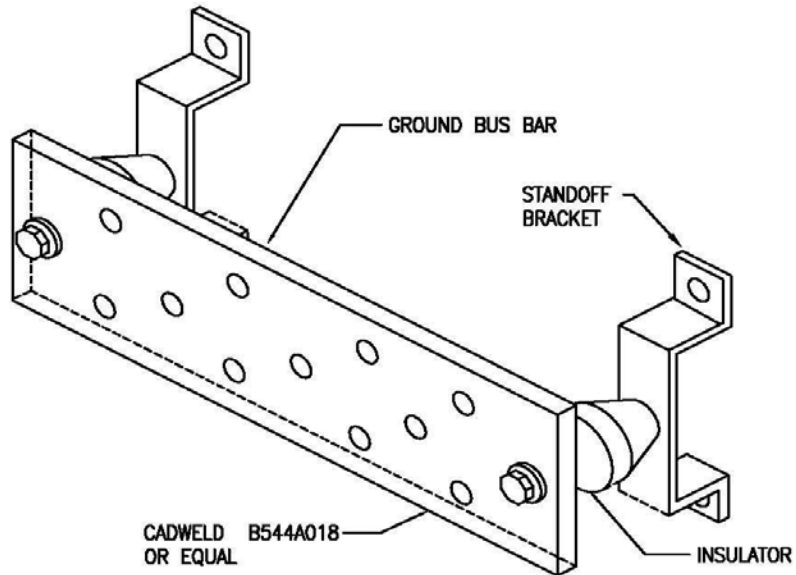

ISOMETRIC ELEVATION

## 6.0 INSTRUCTIONAL TECHNOLOGIES SPECIFICATION

**NOTE:** For any questions regarding any audio-visual or distance learning applications/equipment, contact Joanne Julia at 561-297-2114.

### OIT Audio Visual Standards for eClassrooms and Conference Rooms

#### 1. Power, Data and Conduit

##### A. Conference rooms with video display:

###### Conduit

- (2) 1-1/4 " conduits from floor box stubbed above ceiling to within 5 ft. of wall plate where video conference equipment and video display resides.  
If display is wall-mounted, include power and (2) 1'1/4" conduit from display mount to location of source equipment (usually located right below to access a media rack to credenza containing source equipment)
- 1 data outlet to cable tray tv height. 1 data outlet tv height stubbed. 1 data outlet with 6 connections in credenza to cable tray. 1 data outlet in credenza to data outlet stubbed at tv height.

###### Power

- Duplex Power behind display mount
- 4 outlet power in location of source equipment
- Power in floor box

###### Data

- 6 data drops at location of source equipment
- Data drops in floor box

##### B. Conference Room with Video Projector:

###### Conduit

(2) 1-1/4 " conduit from floor box to wall plate where video conference equipment or PC resides

- (2) 1-1/4" conduit from location of videoconference conference or computer equipment resides stubbed above drop ceiling

###### Power

- Power in ceiling for projector
- Power in floor box
- Power in location of videoconference or computer equipment

###### Data

- Data drops in floor box
- Data drops in location of videoconference conference or computer equipment

## **eClassrooms:**

### **Conduit**

(2) 1-1/4" conduit from teaching location (may be on wall or in floor box) to projector location

- Conduit from projector location to speaker locations.

### **Power**

- (4) outlet power and data in teaching station location (may be on wall or floor box).
- (2) outlet power in ceiling for projector(s)

### **Data**

- 6 data drops in location of teaching console